

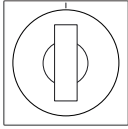



Der Arnold-Schalter® GS 1 passt
in viele Gira Schalterprogramme.

		
cremeweiß	0669 01	GS 1
reinweiß	0669 03	GS 1
reinweiß seidenmatt	0669 27	GS 1
anthrazit	0669 28	GS 1
Farbe alu	0669 26	GS 1
Schwarz matt	0669 005	GS 1

		
reinweiß	0669 112	GS 1

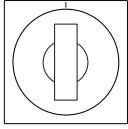
		
reinweiß	0666 66	GS 1
anthrazit	0666 67	GS 1
Farbe alu	0666 65	GS 1

Warum sind die Symbole auf der Gira-Symbolscheibe spiegelverkehrt aufgedruckt?

Der UP-Einsatz ist bei allen Arnold-Schaltern gleich.

Bei Gira werden die Symbole beim Schalten mit dem Knebel auf die „12 Uhr“ Position gedreht.
Zum Beispiel: Rechts drehen = 1x Zeitschaltung.

Montage der Skalenscheibe auf dem Knebel:

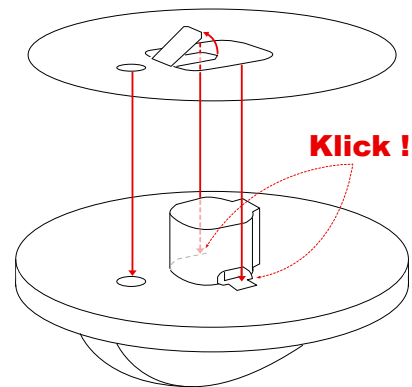

Alle Angaben ohne Gewähr.